

DL3715

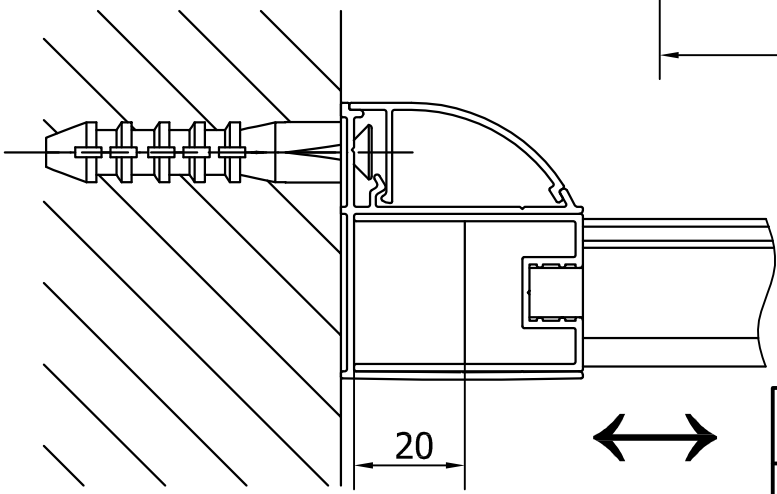

Kreslil vs	Kontroloval	Schválil	Datum	Datum	
---------------	-------------	----------	-------	-------	--

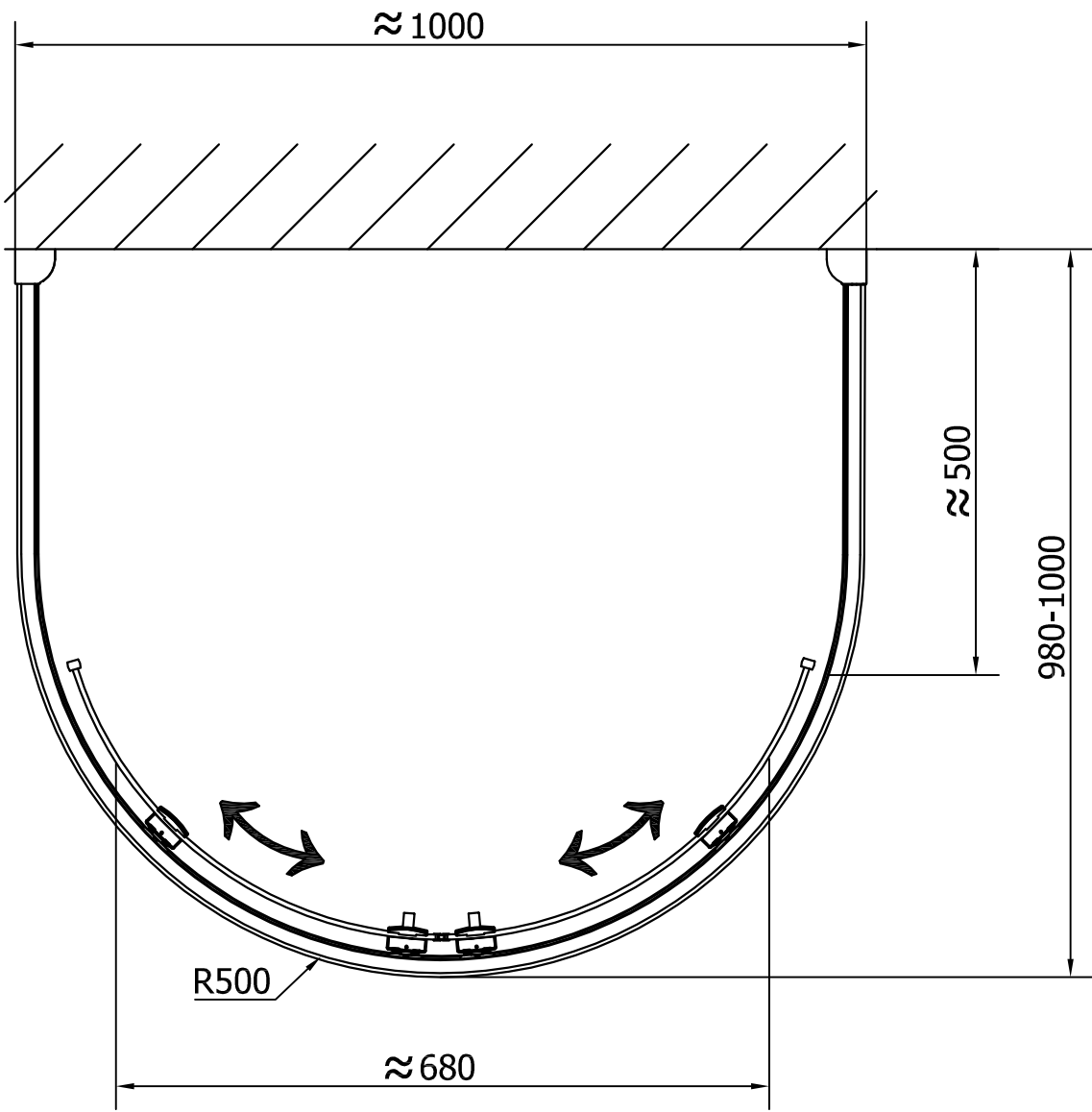

LUCIS LINE

DL3715

Vydání

List

1 / 1